

Article number: 20818509  
Description: E+G Collar nut  
DIN 6331-M6

## Measures

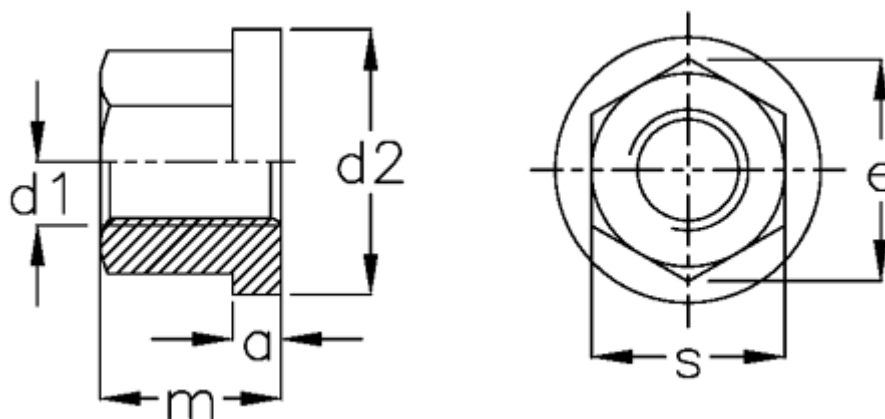

a = 3.0  
d1 = M6  
d2 = 14  
e = 11.5  
m = 9  
s = 10